



Pile Testing Systems

Advanced, Friendly, Robust

Products Catalog



Adrija Scientific Instrument Company

Mob: +91 9163733432

Email: asicoinstruments@gmail.com

Website: www.asicoinstruments.co.in

CHUM

Cross Hole Ultrasonic Monitor

CHUM

CHUM 3DI

5
9



PET

Pile Echo Tester

Model PET USB

Model PET BT

10
13

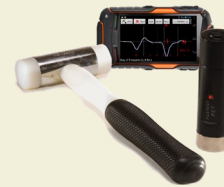

PSI

PSI2 - Parallel Seismic Instrument

16



BIT

BIT - Borehole Inclination tester

18



GPC

GPC Dynamic Pile Testing Systems

N-GAPA Dynamic Pile Testing Systems



Contact Information

Mob: +91 9163733432

Email: asicoinstruments@gmail.com

Website: www.asicoinstruments.co.in

Address: 98B, Belegkata Main Rd, Kulia
Kolkata, West Bengal 700010
India

NOTE: Piletest.com has a policy of constant product improvement.
As a result, specifications may change without prior notice.

GET SUPPORT

— 3 —

GET A QUOTE



PILETEST

Company profile

At Piletest we develop and manufacture systems for quality control / quality assurance of deep foundations since 1996. Our focus has always been on quality, modularity and ease of use.

Quality

All products undergo extensive testing, including pressure chamber, vibration table, heat oven and more, and carry a full three (3) year warranty (Excluding physical damage).

Modularity

We focus on building pile testing systems, not on computers. Therefore, all our products connect to a standard PC, Laptop, Tablet, Smartphone via USB or Bluetooth connection. This approach minimizes your downtime and keeps you up-to-date and independent, and reduces your overall costs.

Ease of use

We take simplicity and usability very seriously. As a result no formal training is usually required and our users usually start using our systems out-of-the-box within minutes. Our ease of use knowhow, is based on years of field work before started designing our own equipment.

Support

It is important for us, as well as it is for you that your final product—the *test report*, is of the highest standards. To help you with this we provide free on-the-job training. We also support you with the analysis of your first projects, and can revise the next ones and comment on the following ones, until we are both satisfied with the results.

CHUM



The CHUM (Cross Hole Ultrasonic Monitor) uses the Crosshole Sonic Logging (CSL) method (ASTM D6760-16) to perform high-resolution quality control on deep foundations. The system uses an ultrasonic wave sent from an emitter to a receiver while both are pulled through water-filled access tubes embedded in the concrete. The measured arrival time and energy are directly related to concrete quality.

Additional methods supported by the CHUM are Single Hole Ultrasonic Testing (SHUT) and Tomography (two- and three-dimensional).

Main features:

- Easy to use; The user-friendly software makes it possible to master the CHUM in less than a day. No additional expensive training required
- Powerful tomography features
- Unlike other system based on an embedded computer (which may soon become obsolete), CHUM connects to the USB port of your regular notebook computer or Tablet PC.
- Automatic Gain Control (AGC)
- Standard Relative Energy (RE) display

The basic CHUM package includes everything required to perform CSL and 2D tomography:

- The CHUM instrument, two ultrasonic transducers, two 50m cable reels, two depth meter pulleys, cables and AC power adapter
- Optional: 100m/150m cable reels, 3D tomography
- Testing, analysis and reporting software
- Interpretation assistance package
- 10 years of free software upgrades
- 3 year warranty on hardware



The **CHUM** system
(computer not included)

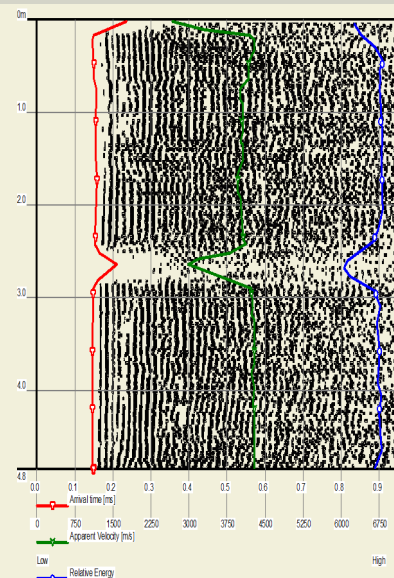

Typical output

3D tomography is available as a free on-line service for 1 year

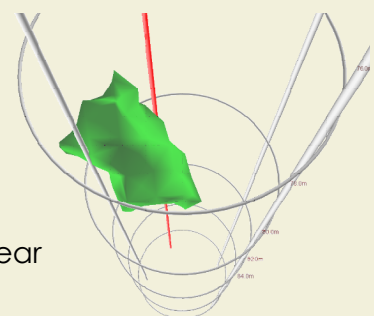

CHUM - Technical Specifications

Physical	Housing	Rugged, Environment-proof, water-resistant housing.
	Dimensions	430mmL x 325mmW x 105mmH (instrument only)
	Weight	3.8 kg (instrument only) 5.0 kg (instrument with typical tablet) 16.0kg (Typical shipping)
	Temperature range	Operating : -25°C to 60°C Storage : -40°C to 70°C
Power	Internal	Rechargeable Lithium Ion battery 11.1V 4.4Ah (two days of typical use)
	External	100-240V AC operation/charging
Standards	ASTM D6760 –16	Meets or exceeds
Technical	Transducers	Dual-Purpose transceivers, 50kHz nominal, pressure-tested housing, 25mm diameter
	Cables	Heavy-duty polyurethane wound on reel
	Sample rate	500kHz (2µS resolution)
	Gain	8 level automatic gain control (AGC)
	Depth meters	Two 24-bit counters. <0.1% error
Performance	Pile lengths	1m to 145m
	Tube spacing	Up to 5m in good concrete
	Productivity	Up to 3000m/Day by a single operator
	Storage	Unlimited
Requirements	Computer (Minimum)	MS Windows Win7/ Win10 / Win 11. Screen resolution 800x600 or higher
Output	Reporting	Arrival time, energy and wave speed curves, “waterfall” presentation, fuzzy-logic and 3D tomography
	Language	Multi-lingual user-interface and reporting
Options	Cable reels	50m, 100m, 150m and custom lengths
	Software	Three-dimensional tomography (Also provided as a service over e-mail)
	Miscellaneous	12V DC car battery power adapter



GET SUPPORT

— 6 —

GET A QUOTE

CHUM - Ordering information

	Part number	Description	Comments
Parts	CH100	CHUM Main unit and charger	(Not sold separately)
	CH200/nnn	Dual purpose single transceiver with 50m, 100m or custom length reel	E.g. CH200/050
	CH410	Depth Encoder	Depth meter wheel that connects with CH350/CH360 to CH100
	CH350	Depth cable (I)	A cable connecting a single CH410 to CH100 for CSL
	CH360	Depth cable (Y)	A cable connecting two CH410 to CH100 for tomography and CSL
	CH510	CHUM car charger/power supply	Not included in packages
	CH500	CHUM 3DT software	3 Dimensional Tomography software enabling visual analysis of test results
	CH601	Extra warranty	Yearly extended warranty beyond the provided 3 years
Packages	CH001	Complete CHUM 50m package	CHUM main unit (CH100) 2 X Transceivers with 50m reels (CH200/050) CHUM software for MS Windows devices 3DT <u>viewer</u> software 2 X Depth meters (CH410) 2 X Depth cables for CSL and tomography (CH350,CH360) On-line Training 3 years Limited Warranty Note - Computer is not included
	CH001+CH002	Complete CHUM 100m package	Same as CH001 but with 2 X CH200/100 instead of 2 X CH200/050
	CH001+CH003	Complete CHUM 150m package	Same as CH001 but with 2 X CH200/150 instead of 2 X CH200/050



GET SUPPORT

— 7 —

GET A QUOTE

CHUM - Ordering information



* Note: Tablet PC is NOT included.



GET SUPPORT

GET A QUOTE

CHUM 3DT



The CHUM 3DT (3D Tomography software for CHUM) is the most advanced, easiest to use and highly practical 3DT solution available today.

3D Tomography reveals and organizes information about flaws in the piles in a human-readable form and helps making well-informed decisions.

Main features:

- Easy to use: Wizard-based interface hides the complexity of the calculations.
- Interactive UI—Zoom, rotate, tilt.
- lightning-fast calculations and graphics.
- Vertical and horizontal slices at any depth/direction.
- Immediate velocity threshold selection.
- Wireframe, Opaque and semi-transparent options help visualize the flaws.
- Create a report in a video clip form, in a document form or hand over the free 3DT viewer for anyone to view the results interactively.
- 10 years free software upgrades.



This link demonstrates the 3DT in video [CHUM 3DT Video](#)

Or search for Piletest on YouTube

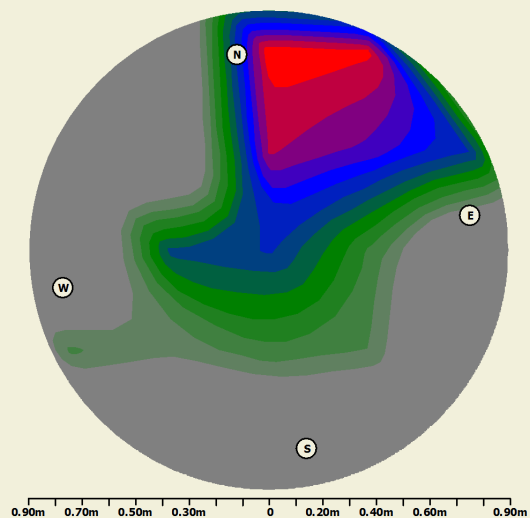
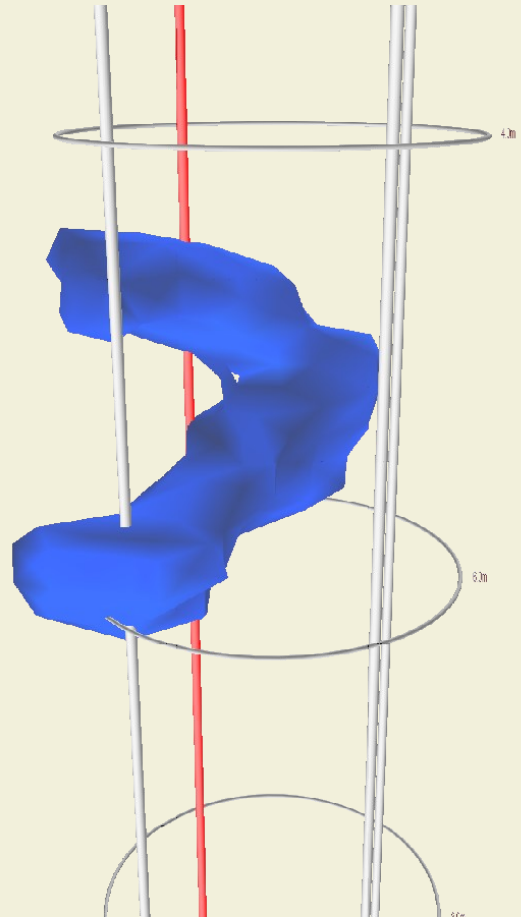

PET - Pile Echo Tester (Model: PET Pro USB)



Piletest's Pile Echo Tester (PET) is a user-friendly, highly flexible solution for testing a large number of deep foundations quickly and accurately.

Requiring little-to-no training, PET is a modular, computer-independent system that attaches to the USB port of any regular notebook or a Tablet PC.

The PET system utilizes the pulse-echo method (compliant with the ASTM D5882-16 & AFNOR P160-2,4 standards). To test a pile, the user strikes it with PET's lightweight handheld hammer. The resulting signal, or reflectogram, is captured by PET's digital accelerometer. It is then transmitted to the computer to produce information about the pile's length and shape. PET Pro USB is CE certified for EMC & Safety requirements Directive 2014/30/EU & LVD 2014/35/EU.

Main Advantages

Ease of use: PET's user-friendly software makes it possible to master the system in less than a day. No additional expensive training is required

Excellent signal quality: PET's super low noise level enables the system to handle extremely long piles

Computer independence: Unlike other system based on an embedded computer (which may quickly become obsolete) PET connects to the USB port of your regular notebook computer or Tablet PC.

Labor saving: PET includes a number of labor-saving features such as advanced project organization; software-suggested wave velocity; Smart Trigger™ and AutoSort to reject anomalous blows; one-touch controls of scale, amplification, and filtering; plus many more features.



Robustness: Specially designed for testing piles, shafts and caissons in construction site environments. The PET sensor is IP67 waterproof and comes with a three (3) year warranty.

The PET Pro USB package includes:

- A digital transducer with waterproof USB cable
- A nylon hammer, spare tips, special putty
- Testing, analysis and reporting software (unlimited number of licenses)
- Interpretation assistance package

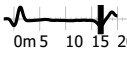
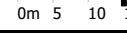
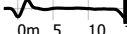

PET Pro USB with a Tablet PC
(not included)

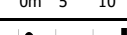
Pile	Depth (m)	Reflectogram	Details	Remark
S*/9	16.8m		Amp:75 Planned:16.0m Avg:5	
S*/13	15.0m		Amp:55 Planned:15.0m Avg:9	
S*/14	15.4m		Amp:55 Planned:15.0m Avg:12	
S*/15	14.0m		Amp:50 Planned:13.0m Avg:17	Anomaly at 5.1m
T/13	14.2m		Amp:120 Planned:14.0m Avg:11	

Typical output



On site

PET Pro USB - Technical Specifications

Physical	Housing Dimensions Weight Temperature range Waterproofing	Industrial grade transducer enclosed in a durable stainless steel and aluminum housing 30 mm (diameter) x 90 mm (Length) 120gr (Transducer) 2.3kg (Shipping) -20°C to +55°C (Operating) -40°C to +80°C (Storage) IP67 (Protection against submersion in water)
Transducer	Sensitivity Linearity Resonance frequency Sampling frequency Sampling resolution	100mV/g Within 1%, 0 to 50g 30kHz 50kHz 24bit
Standards	ASTM D5882-16 AFNOR P160-2,4 CE	Meets or exceeds In conformity to all the essential requirements of CE EMC & Safety requirements Directive 2014/30/EU and Low Voltage Directive LVD 2014/35/EU
Performance	Pile lengths Productivity Storage	2m to 80m (depending on diameter and soil profile.) Up to 100 piles/hour by single operator under favorable conditions Unlimited
Requirements	Computer (not included)	Microsoft Windows Win 7 / Win 10 / WIN 11 800x600 resolution or higher USB port Recommended: Tablet PC (outdoor display)



PET Pro USB - Ordering information

	Part number	Description	Comments
Parts	PT101	Official ISO calibration certificate for PET Pro USB system	
	PT301	Putty (HBM AK22) 1/2 Kg	100g Included in package
	PT302	Hammer	Included in package
	PT303	Replacement hammer heads for hammer (10 pcs)	Included in package (4 pcs)
	PT304	Replacement waterproof mini-USB cable for PET Pro USB	Included in package
	PT501	PET Pro USB warranty (per year)	Additional warranty beyond the included 3 years
Packages	PT001	Complete PET Pro USB package	Including: PET Pro USB sensor and waterproof cable Nylon hammer 4 X replacement hammer heads 100g putty carrying case PET software for MS Widows devices Accelerometer calibration certificate On-line training 3 years warranty. Note: Computer is NOT included.

PT001



GET SUPPORT

— 12 —

GET A QUOTE

PET - Pile Echo Tester (Model: PET Bluetooth)



Piletest's Pile Echo Tester (PET) is a user-friendly, highly flexible solution for testing a large number of deep foundations quickly and accurately. Requiring little-to-no training, PET is a modular, computer-independent system that connects to any compatible computer via Bluetooth protocol.

The PET system utilizes the pulse-echo method (Compliant to the ASTM D5882-16 & AFNOR P160-2,4 standards). To test a pile, the user strikes it with PET's lightweight handheld hammer. The resulting signal, or reflectogram, is captured and transferred to the computer by PET's digital accelerometer, providing real-time information about the length and shape of the pile. PET Bluetooth is CE certified in conformity to all the essential requirements of RED 2014/53/EU

Main Advantages

Ease of use: PET's user-friendly software makes it possible to master the system in less than a day. No additional expensive training is required.

Excellent signal quality: PET's low noise level enables the system to handle extremely long piles.

Computer independence: PET Bluetooth connects to any existing or future computer. PET Bluetooth also connects to any Android smartphone or tablet. There is no dependency on an embedded computer (which may quickly become obsolete).

Labor saving: PET software includes a number of labor-saving features such as advanced project organization; software-suggested wave speed; Smart Trigger™ and AutoSort to reject anomalous blows; one-touch controls of scale, amplification, and filtering - plus many more features.

Robustness: The PET is specially designed for testing in construction environments, with bullet-proof Lexan . It is IP67 waterproof & carries a three (3) year warranty.

The PET package includes:

- A digital transducer
- A nylon hammer, spare tips, special putty
- Testing, analysis and reporting software
- Interpretation assistance package
- Unlimited number of software licenses

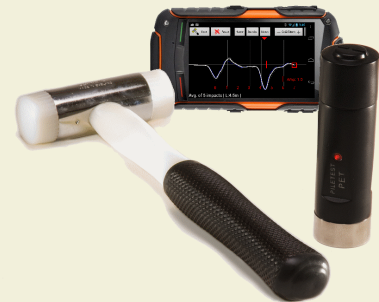

PET Bluetooth with an Android smartphone

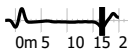
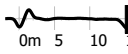
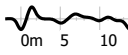
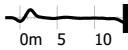

The PET package

Pile	Depth (m)	Reflectogram	Details	Remark
S*/9	16.8 m		Amp:75 Planned:16.0m Avg:5	
S*/14	15.4 m		Amp:55 Planned:15.0m Avg:12	
S*/15	14.0 m		Amp:50 Planned:13.0m Avg:17	Anomaly at 5.1m
T/13	14.2 m		Amp:120 Planned:14.0m Avg:11	

Typical report

PET Bluetooth - Technical Specifications

Physical	Housing Dimensions Weight Temperature range Waterproofing	Industrial grade transducer enclosed in a highly-durable polycarbonate plastic (Lexan) 34 mm (diameter) x 120 mm (Length) 155gr (Transducer without batteries) 3kg (Shipping) -20°C to +55°C (Operating) -40°C to +80°C (Storage) IP67 (Protection against complete submersion in water)
Transducer	Sensitivity Linearity Resonance frequency Sampling frequency Sampling resolution Power	100mV/g Within 1%, 0 to 50g 30kHz 50kHz 16bit 2 AAA Alkaline batteries, 3V total. Sufficient for testing approximately 300 piles
Standards	ASTM D5882-16 CE	Meets or exceeds In conformity to all the essential requirements of RED 2014/53/EU
Performance	Pile lengths Productivity Storage Range	2m to 80m (dependent on diameter and soil profile.) Up to 100 piles/hour by single operator (under favorable conditions) Unlimited Up to 10m between transducer and computer
Requirements	Computer (Not included)	PC/Laptop/Tablet running Windows Win7/Win10/ Win 11 with Bluetooth hardware — or — Android smartphones or tablets with the latest Android version or one earlier , with Bluetooth hardware



PET Bluetooth - Ordering information

	Part number	Description	Comments
Parts	PT301	Putty for PET Bluetooth (HBM AK22) 1/2 Kg	100g Included in package
	PT302	Hammer for PET Bluetooth	Included in package
	PT303	Replacement hammer heads for PET Bluetooth hammer (10 pcs)	Included in package (4 pcs)
	PT501	PET Bluetooth warranty (per year)	Additional warranty beyond the included 3 years
Packages	PT002	Complete PET Bluetooth package	<p>Including: PET Bluetooth sensor Batteries Hammer 4 X replacement hammer heads 100g putty Carrying case PET software for office computer PET software for Android device is available on Google Play store Accelerometer calibration certificate On-line training 3 years warranty. Note: Computer is NOT included.</p>



GET SUPPORT

— 15 —

GET A QUOTE

PSI - Parallel Seismic Instrument

PSI uses the well-known Parallel Seismic method to establish the depth of existing foundations (specifically piles) where the superstructure precludes access to the pile heads.

The test requires the installation of a plastic access tube in parallel, and as close as possible, to the tested pile. The tube should be carried down to a depth exceeding the assumed pile length by a margin of 8-10 m and filled with water. In unsaturated soils the tube should be firmly grouted in the hole to achieve good acoustic coupling with the surrounding soil.

System Components:

- (1) PSI instrument
- (2) Sledgehammer with a trigger switch
- (3) Digital depth meter
- (4) Hydrophone

* PSI2 is compliant with AFNOR NF P94-160-3

Operation:

As the hydrophone is lowered in stages inside the access tube, the superstructure is hit with the hammer and the pulse arriving at the hydrophone is recorded in the PC that is connected to the instrument. When all the pulses thus collected are plotted versus the respective depths, they show a typical break in the slope at the depth where the pile tip is located.

Advantages:

- Ease of use: It is usually self-taught in less than a day. No additional expensive training is needed.
- Connects to any PC/Laptop via a standard USB port.
- Interpretation assistance and Second Opinion Services (SOS) included.



PSI 2 System Components

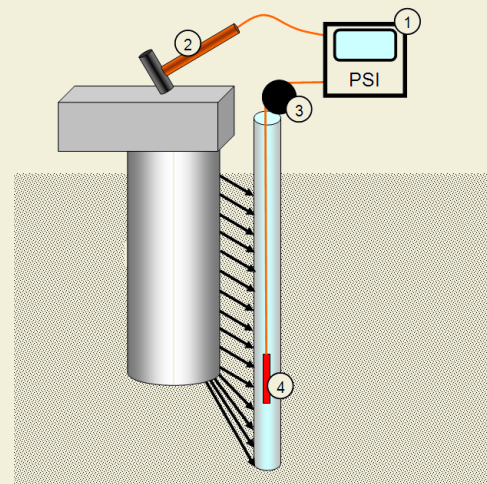

System Components

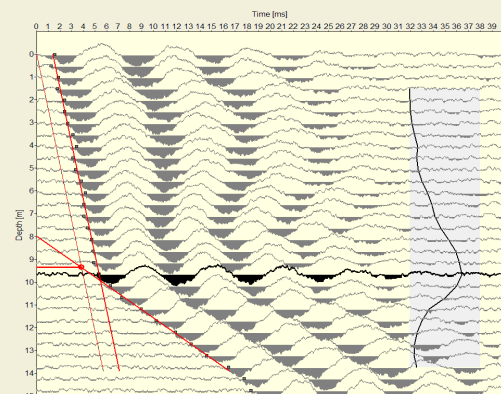

Wave response display

PSI - Technical Specifications

Physical	Housing Dimensions (mm) Weight Temperature range	Rugged, Environment-proof, 210W x 140L x 40H (instrument only) 0.8 kg (instrument only) 2.3 kg (with typical computer) 13.0 kg (Typical shipping) Operating : -25 to 50 (°C) Storage : -40 to 70 (°C)
Power	External—USB	Operate on the USB connection to the tablet or computer device.
Standards	AFNOR NF P94-160-3 ASTM D8381-21	Fully meets or exceeds
Technical	Hydrophone Cables Sample rate Gain Depth	100Hz ~ 4kHz in stainless enclosure. 25 mm diameter Heavy-duty polyurethane on reel. 50kHz (20µS resolution) 16bit A/D + 14 gain levels = 30bit dynamic range . 3mm resolution <0.1% error.
Performance	Pile lengths Productivity Storage	1m to 50m 10-15 min (depending on pile length) per pile Unlimited
Requirements	Computer (32/64 bit)	MS Windows Win7/ Win10/ Win 11 Screen resolution 800x600 or higher
Output	Reporting Language	Arrival time vs. depth Pile tip depth Wave speed in pile Multi-lingual report generation in MS Word format
Depth	Cable reels	50m lengths



GET SUPPORT

— 17 —

GET A QUOTE

BIT - Borehole Inclusion Tester



All piling specifications prescribe the allowable deviation of the pile axis from the vertical. Typical limits vary between 1.33% (UK ICE) and 2% (US FHWA). In diaphragm and secant pile walls, the specification is typically more restrictive.

Unlike traditional systems, BIT uses the auger/bucket itself as a centralizer, thus eliminating the need for a bulky system. The BIT enables fast and accurate determination of inclination in both dry and wet boreholes, vertical or raked.

BIT is compliant with the ASTM D8232-18 standard.

Large boreholes and diaphragm-walls may be quickly tested several times during drilling to enable real-time corrective action. [Operation in a Borehole](#)

Finished pile inclination can be measured through the CSL access tubes. [Operation in a Pile](#)

System components:

- (1) BIT instrument, microcontroller-driven, with wireless communication to peripherals and durable cable connection to the sensor.
- (2) Sensor including precision bi-axial inclinometer and a gyro, waterproof to 160m.
- (3) Wireless depth encoder.
- (4) Android smartphone or tablet with software and Bluetooth communication (not included).
- (5) Access-tube adapter / centralizer (optional)

Operation:

In the open hole, the inclinometer is rigidly attached to the drill bit (bucket or auger) and the depth encoder hung from the rig. The bucket is then lowered (with minimal axis turning) into the open hole. The descent is stopped at predetermined depths for inclination reading and the deviation calculated in real time by integrating the inclination over depth. When pulling the bucket upwards to the surface, the procedure is repeated. The resulting closure error is distributed over the whole depth.

With the optional access-tube adapter, the BIT can also check the as-made inclination of bored piles.

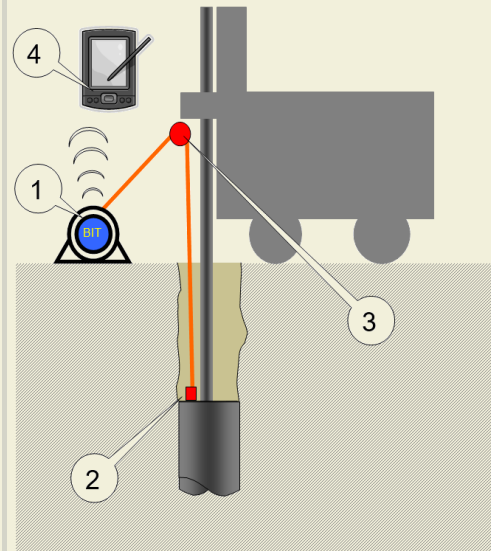

Schematic view

The BIT system with access tube adapter / centralizer

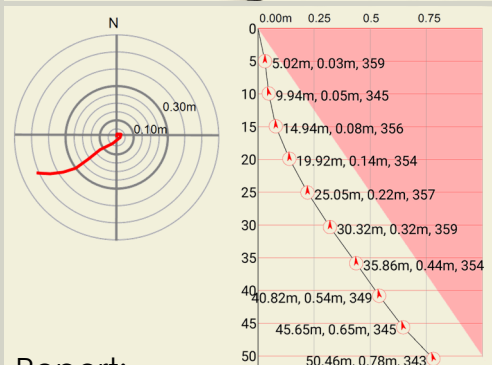
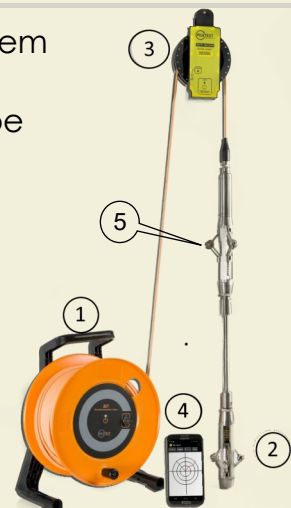

Report:
Top and side view

BIT - Technical Specifications

Physical	Housing Shipping weight Temperature range Humidity Power Waterproof	Sensor : Rugged metal case Instrument: Inside the shielded cable reel 12Kg -10 ~ 50 °C 90% (non-condensing) Internal Li-ion rechargeable battery, 7.4 V 500mAh, sufficient for a full day's work AC adapter/charger included Sensor: IP67, Protection against complete sub- mersion in water Instrument: IP62, 90% condensation (light rain)
Technical	Wireless Depth meter Inclinometer Gyro Cables	Bluetooth, 2.4Ghz Wireless (Zigbee) with internal 1400mAh battery and magnetic charger adapter MEMS, dual axis, temperature-compensated MEMS, Automatic drift compensation 80m (150m optional) rugged Polyurethane
Performance	Borehole depth Borehole diameter Productivity Accuracy	5m-140m Unlimited 10-20 minutes / borehole (Typical) Inclination: 0.1% (0.07°) Depth: 0.05m
Output	Reporting	Produced on office PC, including top view of pile axis, vertical section in the direction of maxi- mum inclination and more. This reporting BIT soft- ware requires MS Windows Win7/Win10/ Win 11 with Bluetooth hardware.
Requirements	Minimum computer	Android smartphones or tablets with the latest Android version or one earlier , with Bluetooth hardware, running the BIT sensors software app, available in Google Play store. No support for MS Windows system or Apple OS









GET SUPPORT

GET A QOUTE

BIT - Ordering information (1)

	Part Number	Description	Comments
Parts	BT1001/80	BIT main unit 	On a 80m reel
	BT1001/custom	BIT main unit 	On custom length cable
	BT1002	BIT sensor 	Inclinometer and gyro in a rugged metal case
	BT1003	BIT wireless depth meter encoder 	Including a charger adapter
	BT1004	Calibration base 	
	BT1005	Compass with adapter 	For setting the North for the sensor
	BT1010	Bucket adapter kit  BT1011 + BT1012 + BT1013	
	BT1011	Bucket mounting base 	Comes with mud plug and 3 arms
	BT1012	Precision Level 	
	BT1013	Spare arms 	3 metal arms to weld on to the centralizer (bucket)

BIT - Ordering information (2)

	Part Number	Description	Comments
Centralizers	BT1020/ 40-60		CSL tube centralizer for diameter 40-60 mm (1.5"-2.5")
	BT1030/ 60-100		Pile tube centralizer for diameter 60-100 mm (2.5"-4")
	BT1031		Wireless Encoder holder for 2.5"-4" pile tube
	BT1040/ 100-150		Pile tube centralizer for diameter 100-150 mm (4"-6") pile tube
	BT1050/ 200-400		Borehole Centralizer for diameter 200-400 mm (8"-16")
	BT1060/ XX-YY		Borehole Centralizer for custom size diameter
Packages	BT1000/ 80m	Complete BIT system for up to 80m boreholes 	Including: BT1001: BIT main unit/80meter BT1002: BIT Sensor BT1003: BIT wireless depth meter encoder BT1005: Compass with adapter Note: Computer is NOT included
	BT1000/ XX	Complete BIT system for boreholes—custom length 	Including: BT1001: BIT main unit/custom length BT1002: BIT Sensor BT1003: BIT wireless depth meter encoder BT1005: Compass with adapter Note: Computer is NOT included



GET SUPPORT

GET A QUOTE

GPC Dynamic Pile Testing Systems.



Piletest's GPC is the next generation of dynamic pile testing systems. It is designed with simplified software and higher ease of use than past systems. The GPC system was started by Professor George G. Goble, the pioneer of dynamic pile analyzers. The GPC complies with ASTM D4945 - Standard Test Method for High-Strain Dynamic Testing of Deep Foundations and Eurocode EN ISO-22477-4.

To test a pile, you need to connect only two dual-purpose sensors to it. The system box can be attached to the pile under test and, via a lossless wireless communication, sends all the monitored data to your computer. This concept makes the construction site work much easier and faster to operate.

To measure four (4) sides of a pile, two main box systems can be operated concurrently with a dual WiFi connection computer. The collected data is processed by three (3) state-of-the-art s/w packages:

GPC Acquisition — For collecting the sensors data and presenting real-time driving plots

GPC Review — Reporting of test results and capable of automatic signal matching

N_GAPA—An Automatic Pile Analysis software for signal matching analysis. Proven to be equal to CAPWAP, and faster.

Main Advantages

Lossless Wireless Transmission: The signal is digitized in the transmitter box. The system is wireless by design using WiFi IEEE802.11ac, which is more reliable than Bluetooth or 2.4 GHz radio of other dynamic pile testing systems.

Cost Efficient: The transmitter box has a wire connection (optional). It uses a low-cost standard CAT5 Ethernet cable (vs. expensive DLT cable) reaching up to 100 meters. Digitization ensures zero signal loss on 100m cable length.

Simplicity: Single data box for both sides of the pile.

Fast to operate: Combination transducer, strain gauge, and accelerometer are combined on one bolt-on sensor minimizing drilling time and complexity.

Intuitive Programming: GUI has been purpose-built to be very intuitive and easy to use with real-time plots.

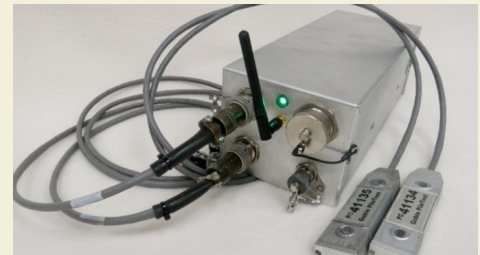

GPC System works with any MS Windows Tablet

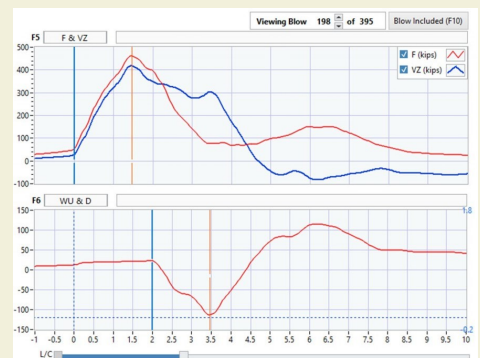

Four (4) clear graphs:
Fi, VZi, F&V, WU&D
(All are presented in L/c scale.
Live capacity plot, presenting soil resistance per each blow)



On site

GPC Pro Wireless - Technical Specifications

Physical (Ver 1.4)	Housing Dimensions Weight Temperature range	Industrial grade DAC enclosed in a durable stainless steel and aluminum housing 102 mm x 160 mm x 305 mm (Ver 1.3) 82 mm x 108 mm x 280 mm (Ver 1.4) 2.3kg (Ver 1.3) 1.9kg (Ver 1.4) -20°C to +55°C (Operating) -40°C to +80°C (Storage)
Sensors	Strain Gage: Resolution Sensitivity Nonlinearity Range Accelerometer: Resolution Sensitivity Nonlinearity Range Sampling frequency Sampling resolution	0.5 me 500 me/mV/V Nom. <0.05% -3600 to +3600 me 0.01 g 0.060 g/mV/V Nom. <0.05% -2000 to +2000 g 10 to 50 KHz 24-bit
Standards	ASTM 4945 EN ISO-22477-10	Meets or exceeds ASTM D4945 - Standard Test Method for High-Strain Dynamic Testing of Deep Foundations and EuroCode EN ISO-22477-10.
Performance	Pile lengths Pile Type	2m to 100m Unlimited (Concrete, Steel, Timber)
Requirements	Computer (included)	Microsoft Windows OS Win 7 /Win 10/ Win 11 1366x768 resolution or better USB port WiFi 802.11ac Recommended for BYOD: Tablet PC (outdoor display)







GET SUPPORT

— 23 —

GET A QUOTE

GPC - Ordering Information

Part number	Description		Comments
GP101	Main Box		To connect 2 GPC dual sensors With WiFi connection
GP201	Dual sensor Accelerometer and Strain Gage		2 sensors in one device. With connection cable.
GP301	<u>Optional</u> 50m cable from main box to computer		This is a backup option for the wireless connection. Uses standard CAT5 cable.
GP302	<u>Optional</u> 100m cable from main box to computer		
GP001	Complete GPC System		Including: <ul style="list-style-type: none"> • Main Box with Wi-Fi 802.11ac connection • 4 X Dual sensor (Accelerometer and Strain Gage, 2 main and 2 Backup) • N_GAPA Automatic Pile Analysis software • Calibration Certificate • Computer preloaded with GPC Acquisition



GET SUPPORT

— 24 —

GET A QUOTE

N_GAPA Automatic Pile Analysis software



Piletest's N_GAPA is the next generation of automatic pile analysis software for dynamic pile testing, comparable to and better than CAPWAP*. N_GAPA software estimates the total bearing capacity of a pile or shaft, as well as resistance distribution along the shaft and at the toe. It is easy to use and super-fast. N_GAPA and CAPWAP results are the same, which can be used on any pile type/shape/ or size. On the right are test results using the GPC system with CAPWAP vs. GPC results with N-GAPA using the same pile simultaneously. The results show a strong correlation between N_GAPA and CAPWAP* analysis software.

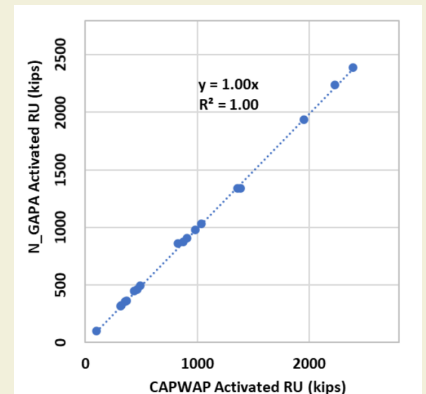

Comparison of CAPWAP VS. N-GAPA results

#	Type	Pile	RU activated				Difference to CAPWAP			Lumped JC
			CAPWAP	N_GAPA	iN_GAPA ₁	iN_GAPA ₂	N_GAP _A	iN_GAPA ₁	iN_GAPA ₂	
1		240-ft	492.7	497.0	492.6	505.5	0.87%	-0.02%	2.60%	0.49
2	H Pile	24.1-ft	366.5	362.0	348.2	359.4	-1.23%	-4.99%	-1.94%	10.00
3		24.5-ft	356.9	357.0	344.5	346.3	0.03%	-3.47%	-2.97%	2.10
4		large QT	463.8	459.0	391.5	395.7	-1.03%	-15.59%	-14.68%	0.30
5	Concrete	long rise time	983	981.0	1005.6	967.7	-0.20%	2.30%	-1.56%	0.38
6			909.9	910.0	840.6	827.6	0.01%	-7.62%	-9.04%	0.40
7	Stinger	Stinger pile	1346.0	1341.0	1391.9	1459.9	-0.37%	3.41%	8.46%	1.64 or 0.88 ²
8		41-ft	323.2	323.0	307.6	309.8	-0.06%	-4.83%	-4.15%	1.20
9	H Pile	107-ft	435.3	446.0	446.1	459.4	2.46%	2.48%	5.54%	1.10
10	Concrete	56.5-ft	1360.3	1343.0	1249.8	1258.5	-1.27%	-8.12%	-7.48%	0.27
11		gradual rise	312.1	315.0	316.5	324.1	0.93%	1.41%	3.84%	0.75
12	Becker	Becker BPT	99.9	98.0	114.8	110.3	-1.90%	14.91%	10.41%	0.68
13		115-ft	874.5	872.0	835.5	860.9	-0.29%	-4.46%	-1.56%	0.51
14	Pipe pile	153.7-ft	1038.1	1029.0	926.3	955.0	-0.88%	-10.87%	-8.01%	0.42
15	Concrete	End Bearing	1950.8	1939.0	1972.6	1954.3	-0.60%	1.12%	0.18%	2.00
16	Auger	140-ft, D=36-in	2391.8	2387.0	2388.6	2388.8	-0.20%	-0.13%	-0.13%	0.00
17	Cast	140-ft, D=36-in	2229.3	2236.0	2232.8	2329.2	0.30%	0.16%	4.48%	0.00
18	H Pile	End Bearing	835.4	863.0	916.0	926.6	3.30%	9.65%	10.92%	2.00
Average			931.6	931.0	917.8	929.9	-0.01%	-1.48%	-0.18%	

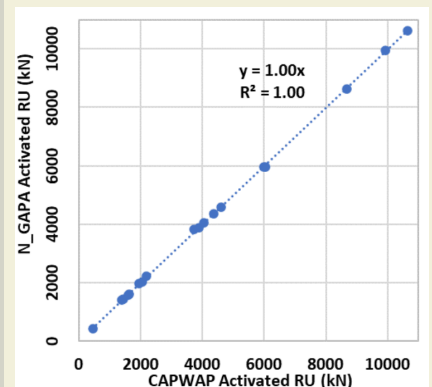

- 1 iN_GAPA from importing txt file
- 2 iN_GAPA results from "Reset Analysis"
- 3 Depending on what LE used while in data acquisition mode

Presenting the strong correlation between N_GAPA and

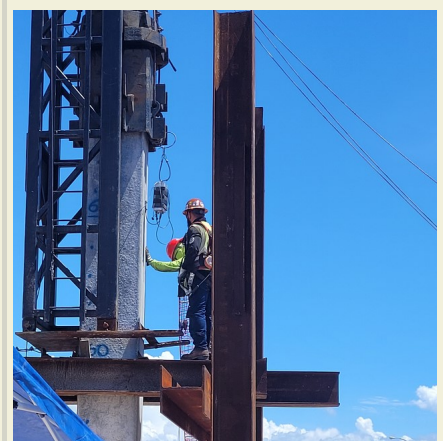
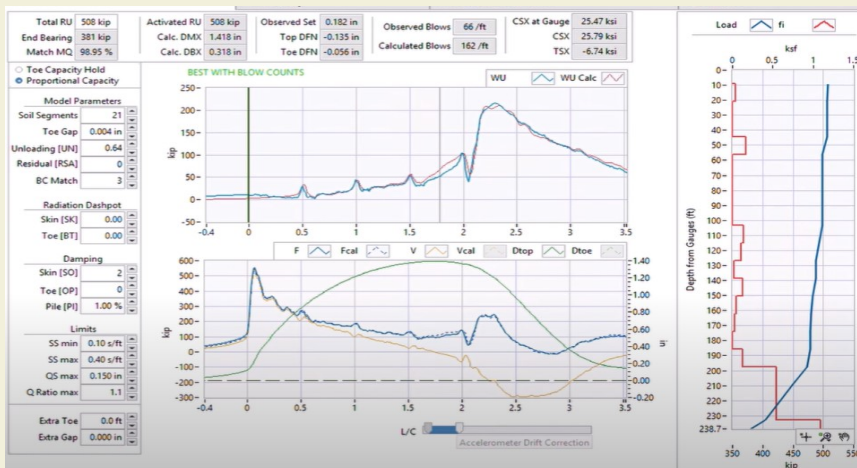

On site

A screenshot from the N_GAPA software, presenting the simplicity and the availability of all the information concurrently.

[See N_GAPA tutorial here](#)

* CAPWAP is a registered trade mark of Pile Dynamic Inc`



Contact Information

Phone: +44 144 278 0919

Email: sales@piletest.com

WEB: www.piletest.com

Address: 18 Fouracres Walk
Hemel Hempstead
Herts HP3 9LB
United Kingdom

File name: Piletest-ASICO-Products_Catalog_2023

GET SUPPORT

— 27 —

GET A QOUTE

